

FLOODED BATTERY

38B20RS (12V36Ah)



CHARACTERISTICS

Item	Specifications	
Nominal Voltage	12V	
Nominal Capacity (20HR)	36Ah	
Reserve Capacity	54min	
Cold Cranking Amps@0°F (-18°C)	335A	
Dimension	Length	195mm (7.68inches)
	Width	126mm (4.96inches)
	Height	222mm (8.74inches)
Approx Weight	9.7kg (21.4lbs)	
Terminal	1	
Cell layout	1	
Hold-Down	B0	
Case	Black-PP Material	
Cover	Black-PP Material	
Handle	TS1	

APPLICATIONS

- Car start
- EV/HEV
- Engine start

GENERAL FEATURES

- High capacity and high CCA
- Long life
- Advanced lead-calcium alloy technology, maintenance-free design
- Patented venting system bring less water loss and prevent acid leakage
- OE quality certification

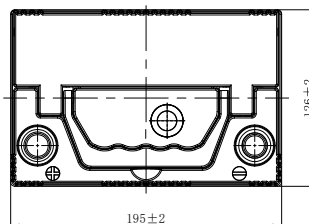
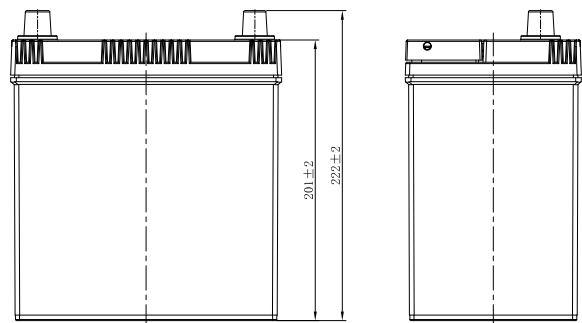
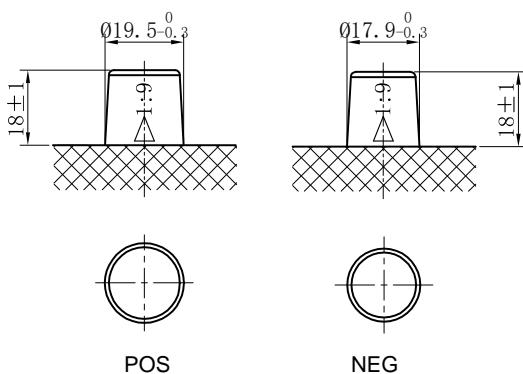

*Values are subject to variation of +/- 5% in normal manufacturing processes.

Leoch International Technology Ltd.
www.leoch.com

Leoch Batteries Pte Ltd
www.leoch.sg

Leoch Battery Corporation
www.leochamericas.com

Leoch Europe S.A.
www.leoch.eu